

AKON



CURTAIN AND DIVIDER

P: 989-414-1209 F: 888-501-5865

www.curtain-and-divider.com

INDUSTRIAL CURTAINS INSTALLATION INSTRUCTIONS

WALL MOUNTING

GETTING STARTED

Open all carton(s) containing hardware and remove all items. Position the hardware on the floor under the opening. Next, look in the box containing the curtain(s).

**Allow the curtain(s) to reach room temperature
(above 50°F/10°C) before unfolding.**

The width and height of the curtain will be listed on a tag attached to the curtain.

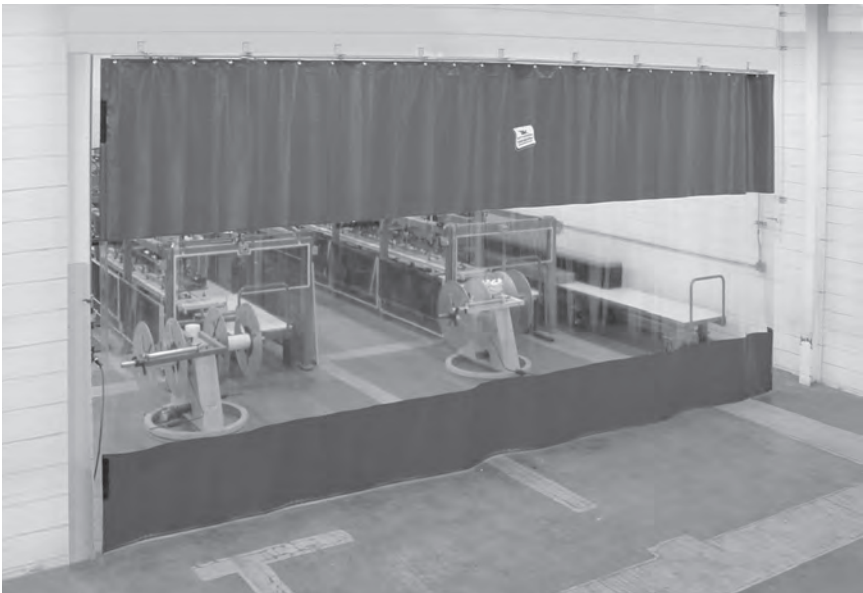

WHAT IS INCLUDED IN YOUR CURTAIN KIT

Please check the chart below to make sure you have the correct number of items.

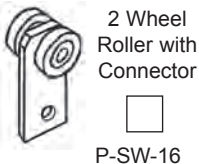
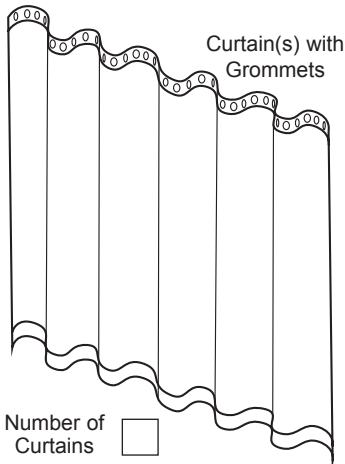
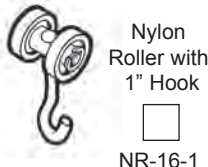
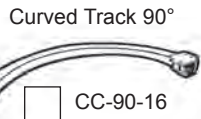
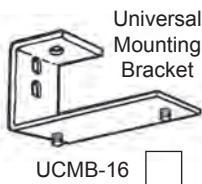
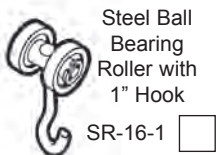
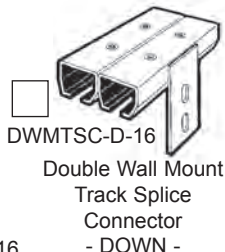
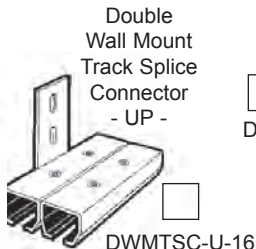
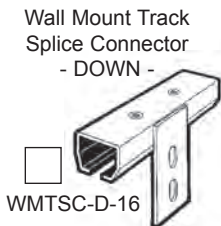
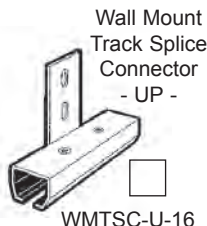
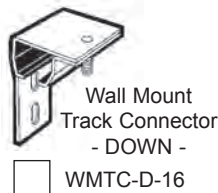
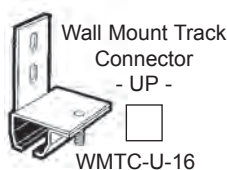
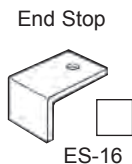
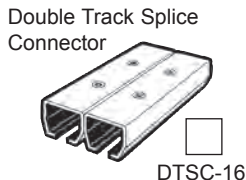
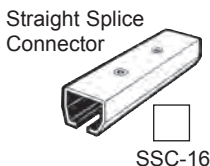
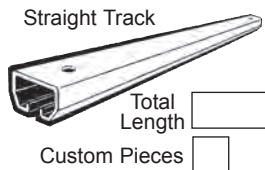

IMPORTANT

Allow the curtain(s) to reach room temperature (above 50°F/10°C) before unfolding.

NOTE: The installer will need an assistant to mount your curtain(s).

The type of wall construction will determine how you fasten the curtain hardware to the wall. Lag screws will be used on drywall, lag screws with anchors will be used for cement block and welding will be used for steel beams.

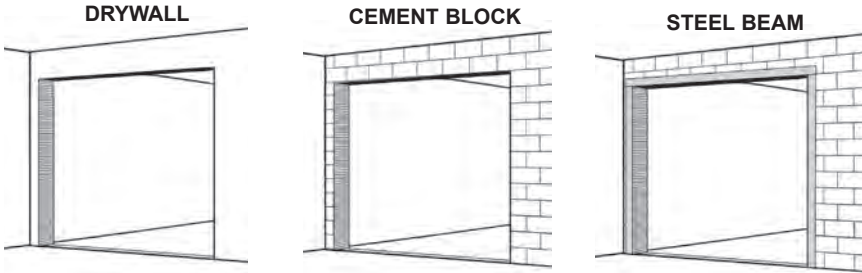

TRACK CONFIGURATIONS

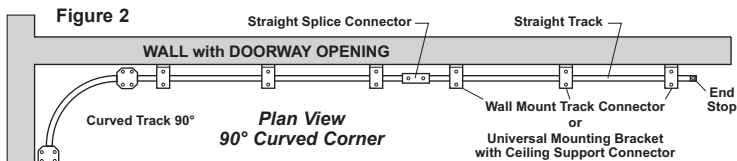
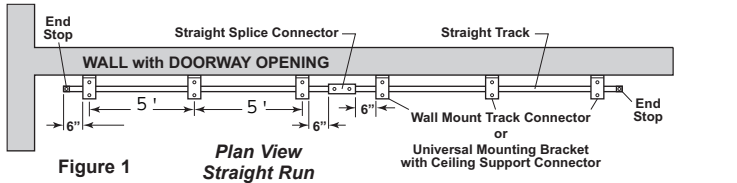

Figure 1 shows a Straight Run using 2 pieces of straight track connected by a splice connector. Track connectors are used to attach the track to the wall and should be spaced 6" from both ends of a splice connector as well as 6" from both ends of the track. **However, it is more important to attach the bracket to solid material than to comply with the 6" measurement.**

The track connectors should be spaced 5' apart. If spacing becomes uneven it is much better to use an extra support bracket than to have a space greater than 5'

Figure 2 shows a Curved Corner. If there is an obstruction on either side of the doorway opening, using a 90° curved corner will solve the problem.

Step 1

SPLICING MULTIPLE TRACKS TOGETHER

Loosen the 2 allen screws on each Straight Splice Connector or Wall Mount Track Splice Connector, one and a half turns.

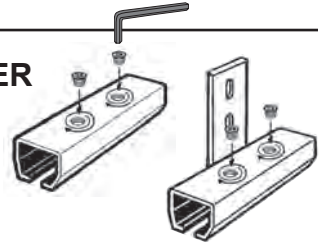

1. Insert the two Straight Tracks into the Connector and tighten the screws. Repeat this process until all pieces of track are spliced together.

TIP: When inserting Track into a Splice Connector or Wall Mount End Stop, lightly clamp a pair of vice grips onto the Track about 4" from the end. This should narrow the Track allowing easier insertion.

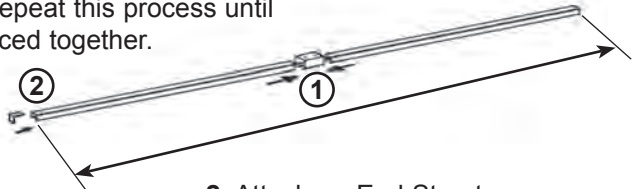

2. Attach an End Stop to just one open end.

The same steps should be taken if Double Track hardware is being used.

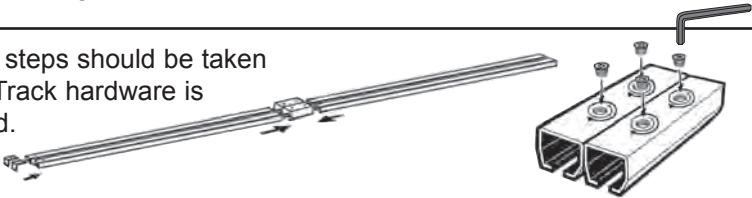

Step 2

MEASURING FOR MOUNTING

The total height of the assembly includes the height of the curtain, the height of the hardware plus an addition 1" to keep the curtain above the floor. A tag on your curtain(s) should show the overall dimensions. The hardware height is shown on the drawings to the right and at the top of page 5.

Universal Mounting Bracket

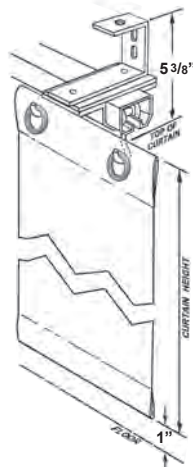

Track Connector - Up -



Track Connector - Down -

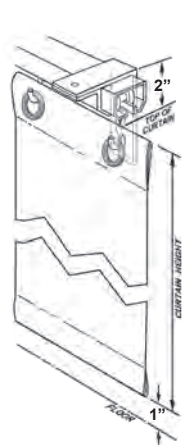

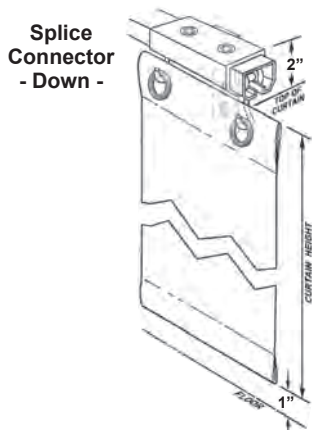
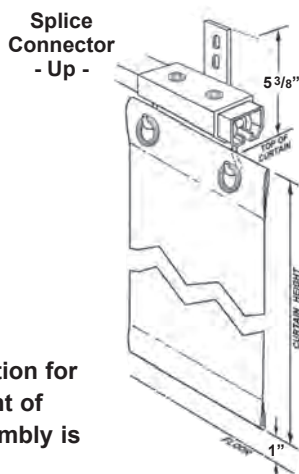

The final calculation for the Overall Height of the Curtain Assembly is as follows:

$$\text{Curtain Height} + \text{Hardware Height} + 1'' = \text{Overall Height}$$

Step 3

PREPARING FOR MOUNTING

1. From the floor and 6" out from one of the edges of the door jamb, place a mark on the wall that is the Overall Height.
2. Using a Line Level, place a mark on the header at least 6" beyond the opposite jamb.
3. Using the 2 marks, stretch a chalk line and snap a line.

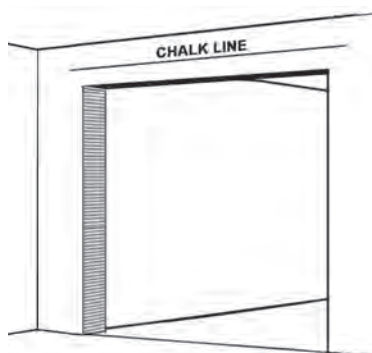
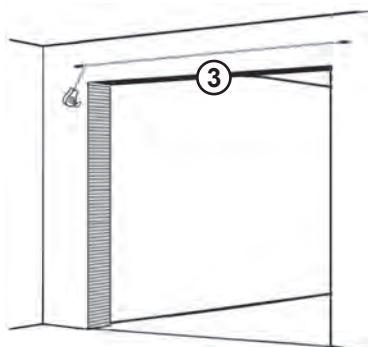
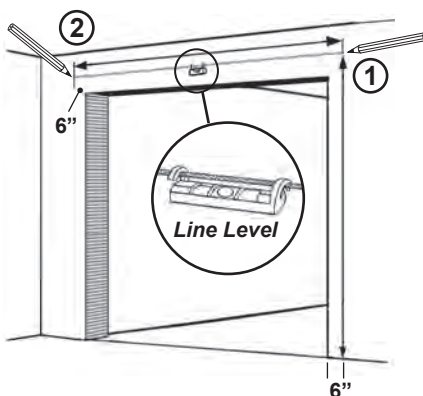

Step 4

ASSEMBLING HARDWARE COMPONENTS

Place all the Support Connectors on the Straight Track and position them according to the type of wall construction. If mounting to drywall it will be necessary to find the appropriate studs and center the Support Connectors on those studs. (See below)

Cement Block and Steel Beam

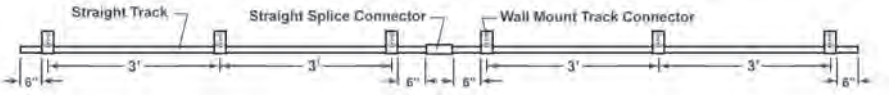

Drywall Over Framing Studs



Step 5

MARKING AND DRILLING (or WELDING)

Using assistance, place the assembly on the wall so the top edge of all the brackets or the top of the mounting bars, depending on the type of Support Connector being used, is even with the chalk line.

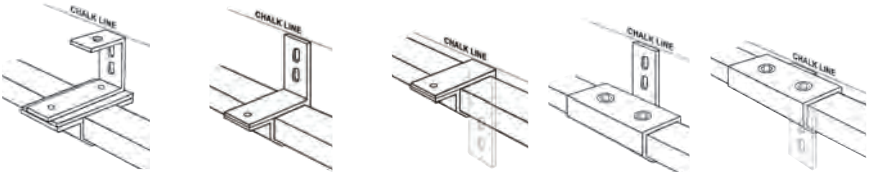

Mark the 2 mounting holes for each of the Support Connectors.

If Track Assembly is too long for easy marking, the assembly can be broken into smaller sections by disconnecting at a Splice Connector. This also should be done if your configuration includes a 90° Curve.

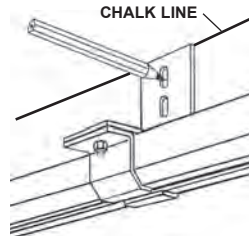

Remove the assembly and drill the 2 holes for each mounting bracket unless you're welding the hardware to the steel beam header.



Step 6

ATTACHING THE ASSEMBLY

Replace the assembly and screw the brackets to the wall using lag screws unless you're welding the hardware to the steel beam header.

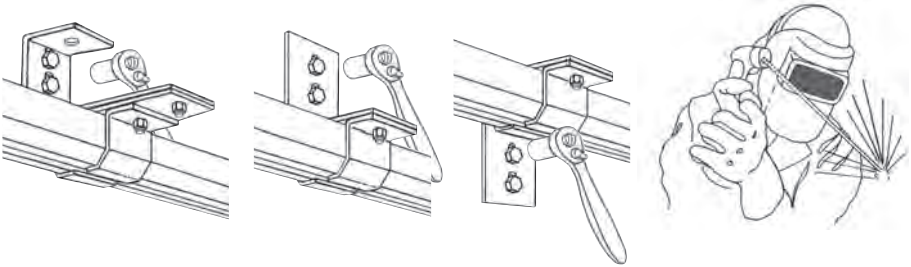

Step 7

INSERTING ROLLERS WITH HOOKS

1. Place each roller into the open end of the track. The number of rollers must be equal to the number of grommets on the top edge of the curtain.
2. Affix the second End Stop to the open end of the track.

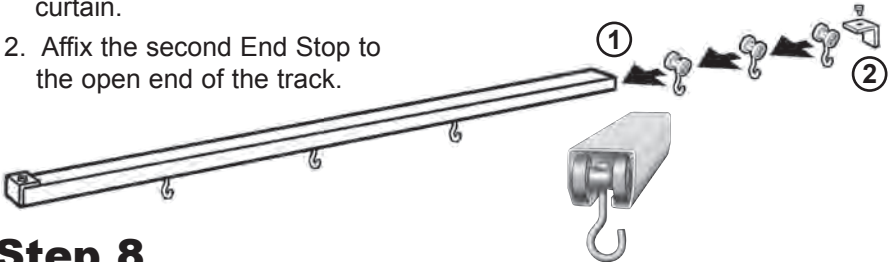

Step 8

HANGING THE CURTAIN

Place each curtain grommet over a roller hook and mounting is complete. The dull side with the logo is the front and should face to the outside.

